

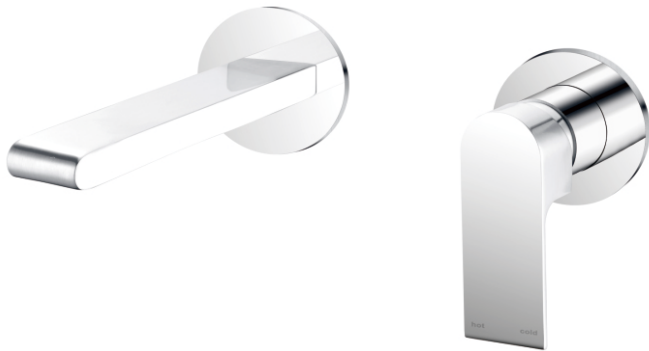





Bianca Wall Basin Mixer



SPECIFICATION

PRODUCT CODE	YSW3215-09E
WELS RATING	5 STAR 5L/MIN
WATERMARK LICENSE	WM-060073
TEMPERATURE RATING	MIN 1°C-MAX 75°C
PRESSURE RATING	MIN 150KPa-MAX 500KPa

FINISH

	CHROME NR321509eCH		MATTE BLACK NR321509eMB
	BRUSHED NICKEL NR321509eBN		GUN METAL NR321509eGM
	BRUSHED GOLD NR321509eBG		

MAINTENANCE AND CARE

All surfaces should be cleaned with mild liquid detergent or soap and water.

Do not use cream cleaners or citrus based cleaning products, as they are abrasive.

Use of unsuitable cleaning agents may damage the surface. Any damage caused in this way will not be covered by warranty.

PACKING INCLUDES

- 1x mixer body
- 2x plate
- 1x handle
- 1x spout
- 1x installation kit

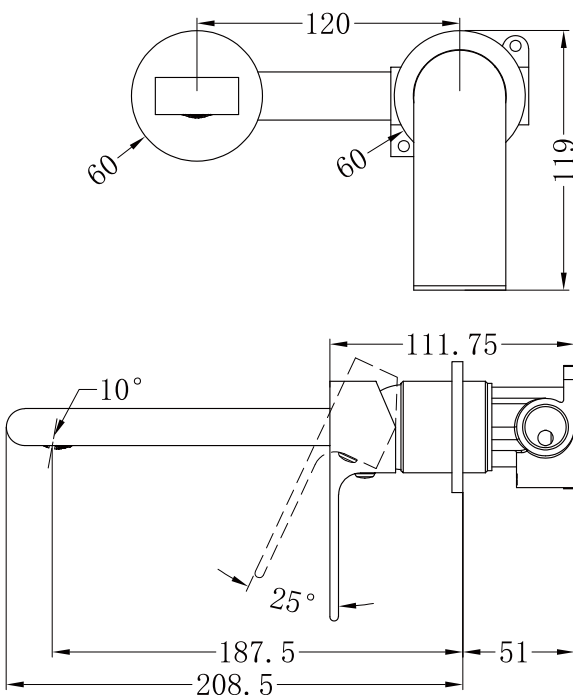

Dimensions are nominal measurements only.

