

# Capo 2-Plate Wall Basin or Bath Mixer

Brushed Nickel

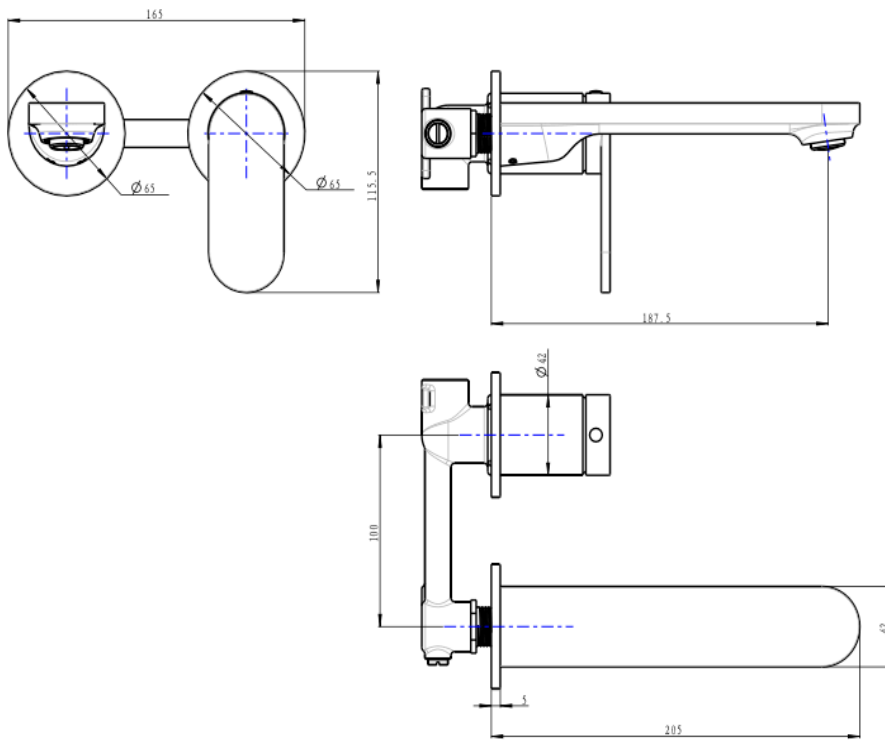

## Product Specifications

Code	CAP-09-2P-BN	Trim Kit	CAP-09-2P-TK-BN (Included)
Barcode	9339897014618	Universal Body	UNI-200 (Included)
Material	Low Lead Brass	WELS Reg	T42252
Finish	Brushed Nickel	WELS Rating	5 Star
Cartridge	Kerox 35mm	WELS L/Min	6L/Min

Experience, *the difference.*



LINSOL.COM.AU

☎ 1300 546 765

@ info@linsol.com.au

✉ PO Box 88, Coniston NSW 2500

Warranty is for domestic use only. All information is correct as at time of writing. The actual product may vary slightly and sizes may be scaled up or down